

Article number: 439500038
 Description: Rota-fix shaft-hub connection F38x65
 Steel
 Note: Self centering. Very high torque

Measures

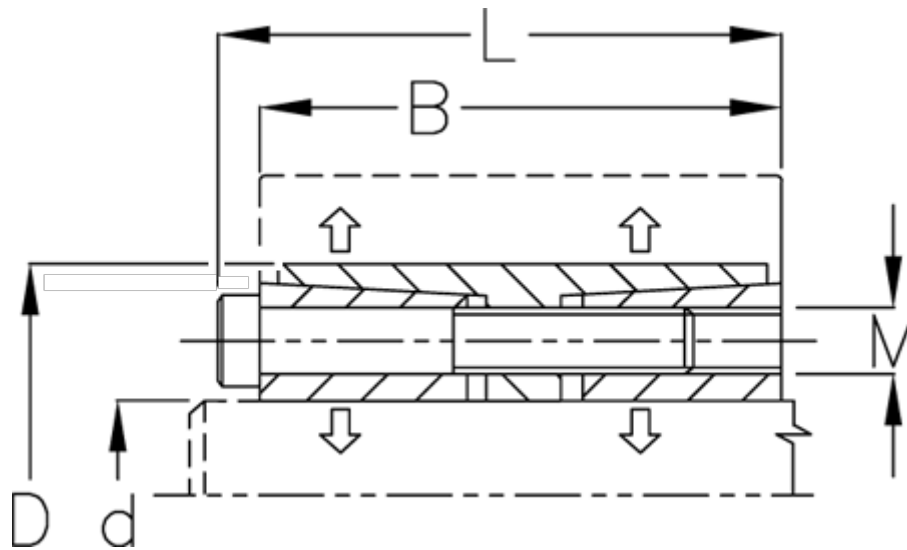

B mm	= 45
d H8 mm	= 38
D mm	= 65
Fit tolerance	= Aksel h8, Nav H8
F kN torque	= 90.0
L mm	= 51
M mm	= M6
P N/mm ² surface pressure on shaft/hub	= 100

Surface roughness	= R? ? 3.2 µm
T N m torque	= 1850
Ts N m bolt tightening torque	= 17.0